

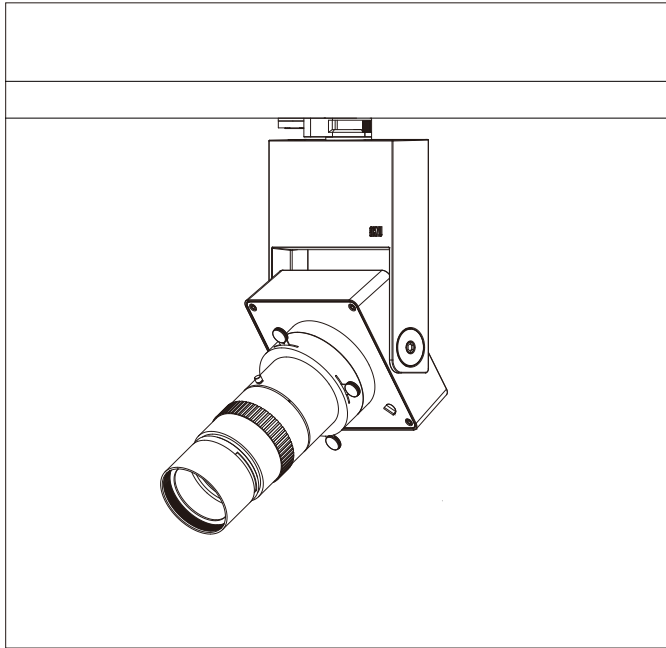

# DUX A5 Framing Projector

Product Data Sheet

665249.000



### Technical Data

Light source: LED  
 Wattage: 28W  
 Voltage: 220-240VAC  
 Nominal luminous flux: 2800lm  
 Beam angle: max 39°  
 Color temperature: 3000K, warm white  
 Color Rendering Index: 95  
 SDCM: <2

### Technical Characteristics

Protection degree: IP20 (EN60598)  
 Insulation class: Class I (EN60598)

### Production Description

Housing and bracket: cast aluminium, powder-coated, black. 0°- 90° tilt.  
 Bracket rotatable through 360° on 3-circuit adapter.  
 3-circuit adapter: plastic.  
 Including electronic control, DALI Plug & Play.  
 Replaceable LED module: chip on board.  
 Weight: 1.70kg

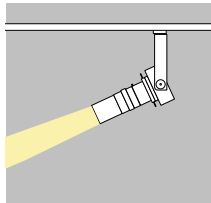

### Dimension

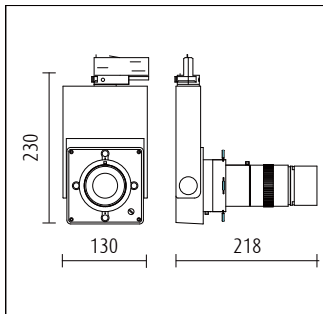

### Lighting Distribution Planning Data

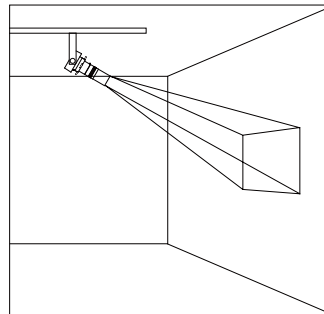

H(m)	D(m)	E(lx)
1	0.50	828
2	1.10	207
3	1.70	92
4	2.30	51
5	2.90	33

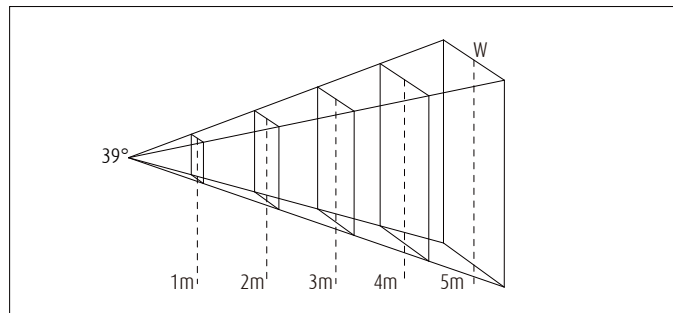

All data, images, and specifications are for reference only and may be changed due to product improvement without prior notice.

More details at [www.akzu.com/665249](http://www.akzu.com/665249)

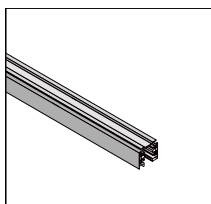

3 circuit track

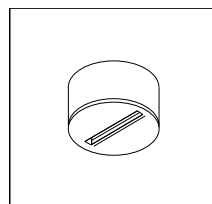

Surface mounted universal mono track point

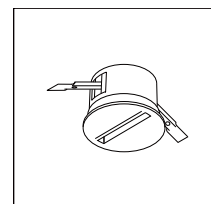

Recessed mounted universal mono track point